

**How to connect up,
build-in, set up, use and
look after your
B1142 oven**

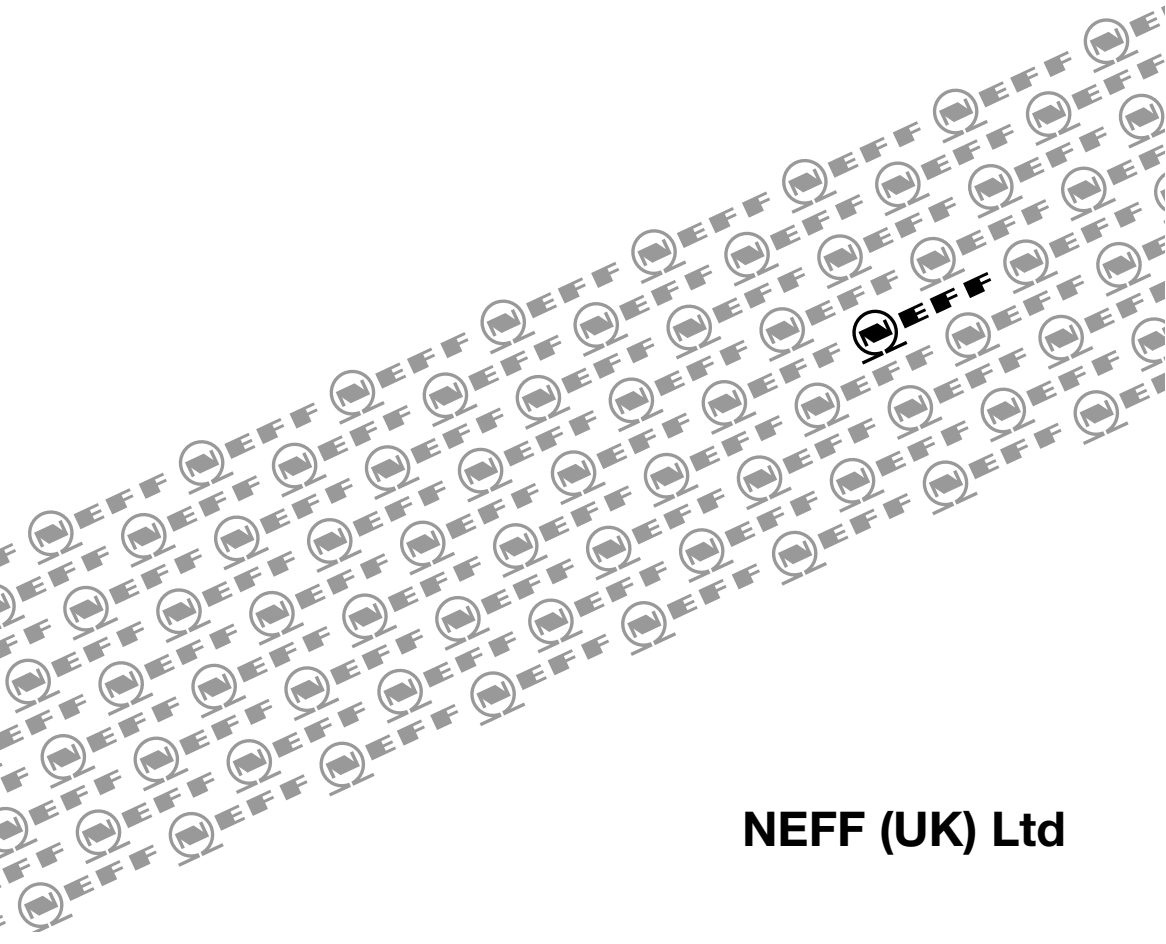

NEFF (UK) Ltd

Table of contents

Important Information	3	Baking	15
Packaging and old appliances	3	Cooking Tips and Helpful Hints	16
Before installation	4	Roasting	17
Safety information	4	Grilling	19
Reasons for damage	5	Surface grilling	19
Your new cooker	6	Defrosting and Cooking	20
The control panel	6	Cleaning and Care	22
Function selector	6	Important cleaning basics	22
Temperature selector	7	Removing/installing the oven door	24
Shelf positions	7	Shelf supports	25
Accessories	8	Service and Repair information	26
Before using your Appliance for the first time	9	Trouble-shooting Guide	27
Preliminary cleaning	9		
Initial burn-in	9		
Subsequent cleaning	9		
Time of day	9		
Electronic clock	10		
The control panel	10		
Minute timer	10		
Automatic timer	11		
Special functions	12		
Description of Oven Features	13		
Switching the oven ON and OFF	14		
		Assembly instructions	
		For the installer and kitchen expert	
		Important installation notes	29
		Installation of the built-in oven	30

Important information



Before using your new appliance, please read these Instructions for Use carefully. They contain important information concerning your Personal safety as well as on use and care of the appliance.

The Instructions for Use apply to several versions of this appliance. Accordingly, you may find descriptions of individual features that do not apply to your specific appliance.

Please keep the operating and installation instructions in a safe place; this important documentation may also be of use to a possible subsequent owner.

Packaging and old appliances

Your new appliance was protected by suitable packaging while it was on its way to you. All materials used for this purpose are environmentally friendly and can be recycled. Please make a contribution to protecting the environment by disposing of the packaging appropriately.

Old appliances are not worthless rubbish. Environmentally-conscious recycling can reclaim valuable raw materials.

Before disposing of your old appliance, please make sure that it is unusable, or label it with a sticker stating „Caution, scrap”.



This appliance is labelled in accordance with European Directive 2002/96/EG concerning used electrical and electronic appliances (waste electrical and electronic equipment – WEEE). The guideline determines the framework for the return and recycling of used appliances as applicable throughout the EU.

Up-to-date information on how to dispose of your old appliance and the packaging from the new one can be obtained from your retailer or local authority.

Before installation

Transport damage

Check the appliance after unpacking it. Do not connect the appliance if it has been damaged in transport.

Electrical connection

The cooker may only be connected by an approved specialist. Losses resulting from damage caused by incorrect connection will invalidate warranty claims.

Safety information

Hot oven

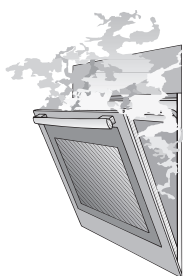

This appliance is intended for domestic use only. Only use the cooker for food preparation.

Open the oven door carefully. Hot steam may escape. Never touch the internal surfaces of the oven or the heating elements. There is a risk of burning. Children must be kept at a safe distance from the appliance.

Never store combustible items in the oven.

Risk of fire. Never place flammable objects onto the hot plates. Fire hazard!

Never place cables of electronic devices onto the hot plates.

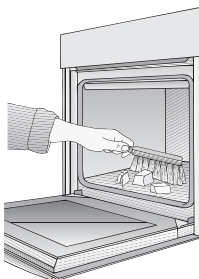

Never clamp leads of electrical appliances in the hot oven door. The insulation on the leads could melt. There is a risk of short-circuiting.

Remove all packaging remnants, e.g. polystyrene parts, from the oven.

Repairs

Incorrectly done repairs are dangerous. There is a risk of electrocution.

Repairs may only be carried out by after-sales service technicians who have been fully trained by BSH.

If there is a fault, switch off the oven fuse at the fuse box.

Call the after-sales service.

Reasons for damage

Baking tray, aluminium foil or dishes on the oven floor

Do not place the baking tray on the oven floor.
Do not cover it with aluminium foil.
Do not place dishes on the oven floor.
This will cause heat accumulation. The baking and roasting times will no longer be correct and the enamel will be damaged.

Slide-in accessories

To avoid damage, insert slide-in accessories carefully.

Baking paper

If using hot air functions , do not place greaseproof paper loosely in the oven (e.g. when heating the oven).
The hot-air fan could draw in the paper which may damage the heater and fan.

Water in the oven

Never pour water directly into a hot oven.
This could damage the enamel.

Fruit juice

When baking very moist fruit cakes, do not put too much on the baking sheet. Fruit juice dripping from the baking sheet leaves stains that cannot be removed.
It is recommended that you use the deeper universal pan.

Cooling with the oven door

Only leave the oven to cool with the door closed. Do not allow anything to become trapped in the oven door. Even if you only leave the oven door open slightly, the fronts of adjacent units may become damaged over time.

Very dirty oven seal

If the oven seal is very dirty, the oven door will no longer close properly when the oven is in use.
The fronts of adjacent units could be damaged.
Keep the oven seal clean.

Using the oven door as a seat

Do not stand or sit on the oven door.

Care and cleaning

Do not use high-pressure cleaners or steam jets.

Your new cooker

Here you will learn more about your new oven. The control panel and its switches and indicators are explained here. The heating modes and the accessories included with your oven will be explained here.



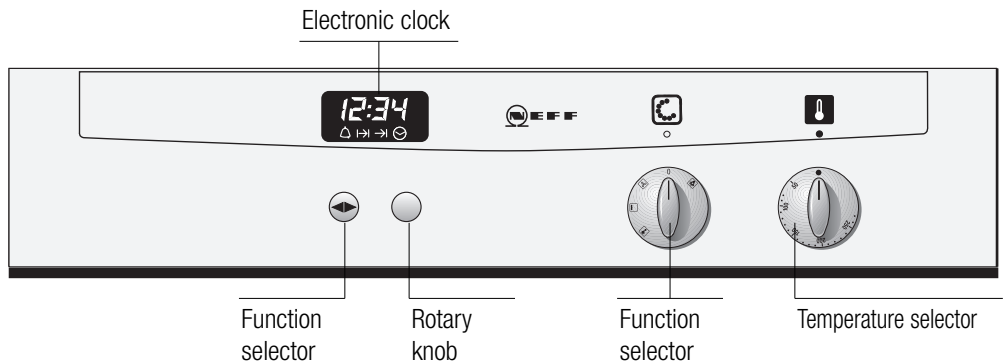

The control panel



Function selector

Use the function selector to select the type of heating for the oven.

Settings

-  Circotherm
-  Surface grilling, large area grill
-  Defrosting position
-  Oven light

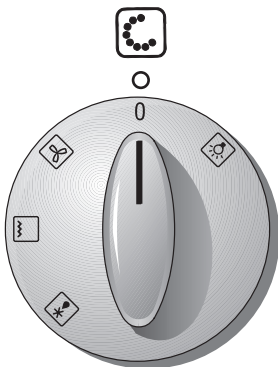

Temperature selector

Settings

50–275 Temperature in °C.

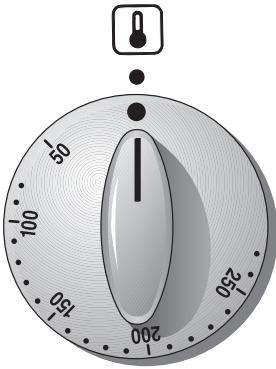

Shelf positions

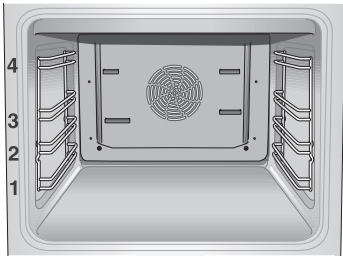

Your oven features 4 shelf positions. **The shelf positions are counted from bottom to top.** The numbers are marked in the oven.

When using **hot air function**  or **roasting**, **do not use shelf position »2«**, in order not to block air circulation.

Accessories

Your appliance is supplied with:

Universal pan with wire shelf



Wire shelf



Additional accessories can be obtained from a specialist dealer. Before ordering, please check the Neff sales literature to confirm which of the following items are available in the UK:

Order no.

Universal pan	Z 1232 X0
Universal pan, non-stick	Z 1233 X0
Glass pan	Z 1262 X0
Soufflé pan	Z 1272 X0
Baking tray, aluminium	Z 1332 X0
Baking tray, enamelled	Z 1342 X0
Baking tray, non-stick	Z 1343 X0
Pizza tray	Z 1352 X0
Wire shelf, high/low	Z 1432 X0
Wire shelf, close mesh	Z 1442 X0
Upgrade set Clou, 3 pieces	Z 1762 X0
Pizza stone	Z 1912 X0
Universal oval roaster enamelled	Z 9930 X0
Oven door guard	440651

Note:

The guard prevents contact with the hot oven door. This is particularly important with small children.

The baking tray or universal pan may distort while the oven is operating. This is caused by major temperature differences on the utensil. These differences may occur if only one part of the utensil was covered or if deep-frozen food, e.g. pizza, was placed on the utensil.

The distortion will already subside again during baking, roasting or grilling.

Before using your appliance for the first time

Preliminary cleaning

Take the accessories out of the oven.

Remove all packaging remnants, e.g. polystyrene parts, from the oven.

1. Clean the appliance exterior with a soft moistened cloth.
2. Remove the shelf supports from the oven.
3. Clean the oven and the accessories with a hot detergent solution.

Please observe the operating instructions furnished with the hob.

Initial burn-in

Before using the appliance for the first time, you must set the time on the electronic clock.

Heat the empty oven for approx. 30 minutes. Select circotherm  at a setting of 190° C.

Subsequent cleaning

Clean the oven with a hot detergent solution. Install the shelf supports.

Time of day

Setting the time



After connecting to the mains, or after a power failure, the display **0:00** will blink.

Press the ◀▶ button and set the current time with the rotary knob (e.g. **15:00** hours).

To correct the time, press the ◀▶ button until the symbol flashes.

Then set the time.

Note: The time cannot be corrected if an automatic function has been set (see Electronic clock for cancelling automatic function).

Electronic clock

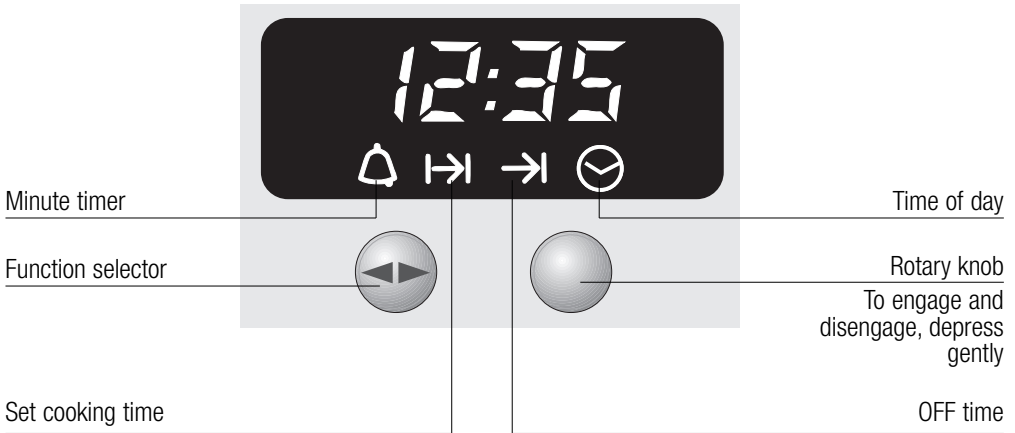

The electronic clock can be operated with one hand; after pressing the button, set the time with the rotary knob. Settings can be made for as long as the function display flashes (~4 seconds).

The control panel



Minute timer



1. Press the  button and set the cooking time (e.g. 5 minutes).
When the timer switches on, the remaining time is displayed.
2. When the time has elapsed, a signal is emitted and the  symbol flashes. To stop the signal, press the .

Automatic timer

Automatic switch off

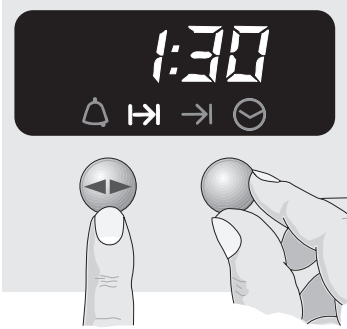

You can switch the oven on and off via the electronic clock.

If you wish to bake or roast food immediately, it is only necessary to set the cooking time.

1. Select the heating system and the oven temperature.
2. Press the ◀▶ button until the ⇨ symbol flashes and set the cooking time with the rotary knob (example: 1 hour and 30 minutes). When the setting has been made, the current time is displayed after approx. 4 seconds. The ⇨ symbol signals automatic mode.
3. When the time has elapsed (example: 1 hour and 30 minutes), a signal is emitted and the ⇨ display flashes. The oven switches off automatically. To stop the signal, press the ◀▶ button.
4. Switch the oven off.
5. To end automatic mode, press the ◀▶ button again.

Automatic switch on and switch off



If the food is to be baked or roasted later on, both the cooking time and OFF time must be set.

1. Select the heating system and the oven temperature.
2. Press the ◀▶ button until the ⇨ symbol flashes and set the cooking time with the rotary knob (example: 1 hour and 30 minutes).
3. Press the ◀▶ button until the → symbol flashes and set the OFF time with the rotary knob (example: 12:30). When the setting has been made, the current time is displayed after approx. 4 seconds. The → symbol signals automatic mode.



Checking, correcting and cancelling settings

Note

4. The oven is automatically switched on and off at the preset times (e.g. 11:00 and 12:30).
5. When the time has elapsed, a signal is emitted and the → symbol flashes. To stop the signal, press the ◀▶ button.
6. Switch the oven off.
7. To end automatic mode, press the ◀▶ button.

1. To check your settings, press the ◀▶ button until the symbol flashes.
2. If required, correct the settings with the rotary knob.
3. If you want to cancel your settings, turn the set time back to 0:00 and switch the oven off.

The automatic timer is best used with dishes which require little attention.

The minute timer and OFF time can be pre-programmed up to a max. 24 hours.

The settings can be displayed at any time by pressing the ◀▶ button.

Special functions

Masking out the display

1. Press the ◀▶ button for 7 seconds. The display then goes blank and the time continues running in the background.
2. To switch on the display, briefly press the ◀▶ button.

Setting the time

See section "Before using your appliance for the first time".

Dimming the display

Between 22.00 and 6.00 the display is automatically dimmed.

Description of Oven Features

Circotherm



A fan system located in the rear oven wall circulates the circotherm in the oven, achieving an especially effective heat transfer to the food being baked or roasted.

Advantages:

- Simultaneous baking and roasting possible on up to 3 levels
- low soiling of oven interior
- shorter preheating times
- low oven temperatures

Large area grill



The food being prepared is exposed to heat radiation from the heating element at the top of the oven cavity.

- Particularly effective with flat, small cuts of meat, i.e., steaks, sausages, fish, vegetables and toast.

Defrost



A fan in the rear wall of the oven circulates the air in the oven around the frozen food.

The fan system is running without heating.

Advantages:

- Gentle defrosting.
- Frozen pieces of meat, poultry, bread and cakes defrost evenly.

Switching the Oven ON and OFF

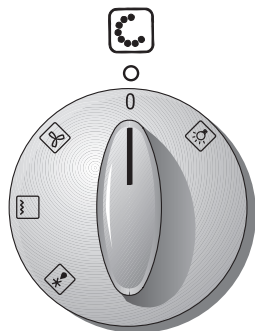

Before switching on your oven, you should decide which heating system you wish to use.

Switching the oven ON:

1. Use the function selector to determine the desired system.
2. Set the temperature control knob to the desired temperature.

The selected temperature will be controlled automatically.

The oven temperature control lamp illuminates when the oven is first switched on, and extinguishes when the required temperature has been reached.

Switching the oven OFF:

To switch the oven OFF, turn both the temperature selector and functions selector to the »0« position.

Notes:

The appliance features a cooling fan which runs until the oven has cooled down.

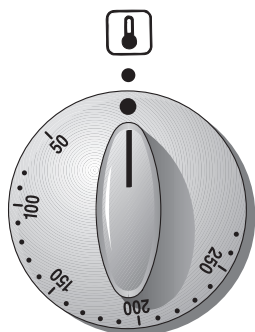

Baking

Using baking tins

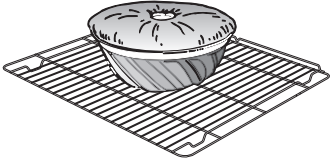

Always place baking tins in the centre of the wire shelf.

The wire shelf may be turned upside down to accommodate different size tins.

Notes

You can influence the degree of browning by changing the temperature setting.

Light coloured baking tins made from thin-wall materials lead to longer baking times and uneven browning of the cake.

If a cake collapses after removing it from the oven, consider using a longer baking time, or use a slightly lower temperature setting.

Using tinplate baking tins



Circotherm

Shelf position 1

If the cake bottom gets too dark:

Check the shelf position. Shorten the baking time, and possibly use a lower baking temperature.

If the cake bottom stays too light:

Check the shelf position. Increase the baking time, select a lower temperature, or use a dark metal baking tin.

Do not place baking tins or high cakes too close to the rear oven wall.

Cooking Tips and Helpful Hints

The bottom of a cake baked on a baking sheet stays too light	Remove from the oven all baking sheets or universal pan currently not in use.
The bottom of a cake baked in a tin stays too light	Use a wire shelf and not a baking sheet to support the cake tin during baking.
The bottom of cake or cookies gets too dark	Set cake or cookies into a higher set of shelf position.
The cake gets too dry	Select a slightly higher oven temperature, and shorter baking time.
The cake is too moist on the inside	Choose a slightly lower baking temperature. Note: Higher temperatures do not shorten baking times (done on the outside, raw on the inside). Choose a slightly longer baking time, allow the dough to rise slightly longer. Add less liquid to the dough.
When baked with circotherm, cake baked in round or square tins gets too dark at the rear	Avoid blocking the air vents at the rear wall of the oven cavity with the cake tins.
Very moist cake dough (e.g. fruit cake) causes a lot of steam to generate in the oven that condenses on the oven door.	You can let the steam escape from the oven and thereby reduce the forming of water droplets by briefly and carefully opening the oven door (once or twice, in case of longer baking times more often).
Very uneven browning when using circotherm	Check the shelf position.
Cake collapses when taken out of the oven	Use less liquid.
To save energy	Preheat only if expressly required by the recipe. Dark baking tins have a higher degree of heat absorption. Residual heat: In the case of longer baking times, you can switch off the oven 5-10 minutes before the full baking time has elapsed.

Roasting with circotherm

Notes

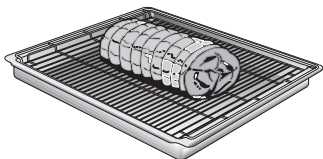

Place the wire shelf into the universal pan and slide them together into the same shelf position. Meat roasted using the Circotherm system will brown on all sides and stay moist without additional fat.

Choose cuts of meat that weigh 150 grams (5oz) or more.

Place the shelf on top of the roasting pan.

Place the meat on the shelf, season if desired.

Slide the pan and shelf into the oven on the same shelf position.

No pre-heating is required. Save energy by putting the roast into the cold oven.

Use a Circotherm temperature of 160 °C.

Circotherm grilling

Use this method for small cuts of meat – steaks, chops, sausages, bacon, chicken joints and fish.

Use the shelf and roasting pan together.

Season meat as required.

Place on shelf.

Do not turn food over – the hot air will circulate around the food cooking all sides.

Use a temperature of 180–190 °C.

Casseroling or pot-roasting in a covered dish

Some meats should be prepared in liquid in a covered casserole. This type of cooking is suitable for less tender cuts of meat.

Place the casserole on the wire shelf on a suitable shelf position.

Cooking tips

Only use ovenproof cookware.

Extra large turkeys and joints can be placed directly in the roasting pan and not on the wire shelf.

Cover large turkeys with foil during cooking. Remove foil during the last hour.

The roast is not done on the inside

Use a lower roasting temperature.

Note: Higher temperatures do not shorten roasting times (done on the outside, raw on the inside).

Choose slightly longer roasting times.

Very moist roasts (e.g. roasts prepared with water) cause a lot of steam to generate in the oven that condenses on the oven door.

You can let the steam escape from the oven and thereby reduce the forming of water droplets by briefly and carefully opening the oven door (once or twice, in case of longer roasting times more often).

Grilling

Radiant grilling

Used for small cuts of meat or poultry.

⚠ Exercise CAUTION when grilling.
Always keep children away from the oven when it is in use.

Notes on grilling

Always close the oven door when grilling.

The grilling temperatures are variable.

Always use the wire shelf and roasting pan together.

Turn the food after approx. two-thirds of the grilling time has elapsed.

Lightly brush the wire shelf with oil and baste the food if desired.

Surface grilling

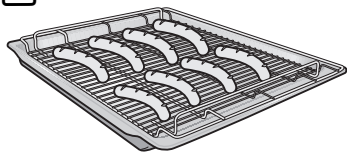

Always place the food to be grilled in the centre of the wire shelf.

If the heating element switches off automatically, the overheating protection was activated.

The element will be reactivated after a short period of time.

Defrosting and cooking

Defrosting with circotherm

Important heating system
information

For defrosting and cooking of frozen foods,
use circotherm.

**With all frozen foods, follow the food
manufacturers instructions on the package.**

As a rule, **defrosted frozen foods** (especially meats) require less cooking time than fresh products, since freezing has a pre-cooking effect.

If **frozen meat** is placed in the oven, the defrosting time must be added to the required cooking time.

Always defrost **frozen poultry** before cooking because the giblets must be removed.

For cooking **frozen fish**, use the same temperatures as for fresh fish.

Frozen ready-to-eat meals in aluminium dishes may be placed into the oven several at a time.

Frozen vegetables (i.e., when cooking complete meals) should be cooked in a covered pot together with the roast. Use only approximately half of the liquid specified in the recipe. Use fat only for adding flavour.

Shelf position

With 1 baking sheet: Shelf position **1**

With 2 baking sheets: Shelf positions **1 + 3**.

All stated times are approximate guidelines that vary with the shape and volume of frozen products.

Defrosting and setting

Raw frozen products or foods from a freezer

always defrost at 50° C.

Higher defrosting temperatures may cause the food to dry out.

Defrost **frozen meals packed in aluminium foil or closed aluminium containers** at a setting of 130 – 140° C.

Place frozen meals **packed in plastic bags or plastic containers** in a pot filled with water. Cover the pot and defrost of 130 – 140° C.

Attention: Pot handles must be oven-proof.

Defrost and warm up **frozen baked goods** at 100 – 140° C. Brush bread, rolls or yeast pastry lightly with egg to make the crust more appealing.

Defrost **dry frozen yeast cakes** at 160 – 170° C for 20 – 30 minutes.

Defrost **moist frozen yeast cakes** (with fruit topping) at 160 – 170° C for 30 – 50 minutes after wrapping in aluminium foil to prevent cake from drying out.

Defrost and toast **frozen toast** (with topping) at 160 – 170° C for about 20 minutes.

Defrost and bake **frozen pizzas** at 180–190 °C for 15–25 minutes.

Place on wire shelf covered with greaseproof paper. Please ensure that the greaseproof paper is suitable for use at these temperatures.

Defrosting position

Recommended for delicate pastries only (i.e., whipped-cream gateaus).

Turn the function selector switch to the  position. Dependent on size and type of the baked goods, defrost 25 – 45 minutes, take out of the oven and allow to stand 30 – 45 minutes.

With smaller amounts (pastries), the defrosting time is reduced to 15 – 20 minutes and the subsequent standing time to 10 – 15 minutes.

Cleaning and Care

Important cleaning basics

For cleaning, do not use abrasives, no corrosive cleaners, and no sharp objects.

Do not scratch off burnt-in food residues, but soak them off with a moist cloth and dishwashing detergent.

Cleaning products we particularly recommend can be purchased from our customer service.

Appliance exterior

Stainless steel/ aluminium front

Use commercially available detergents applied to a soft, moistened cloth or a chamois.

Do not use aggressive cleaning agents, abrasive sponges, or coarse cleaning cloths.

On heavy soiling use commercial cleaning agents on matted stainless steel/aluminium surfaces.

Please observe the manufacturer's instructions.

Enamel and glass

Use commercially available detergents applied to a soft, moistened cloth or a chamois.

Oven door pane

The temperature of the pane inside the oven door is reduced by a heat-reflecting coating.

The reduced temperature ensures that visibility through the oven door window is not impaired.

When the oven door is open, this coating may have a bright appearance. This is quite normal and does not indicate a quality defect.

Oven interior

Clean the oven after each use, especially after roasting or grilling.

Food remnants burn in when the oven is reheated. The baked in remnants are very difficult to remove once burnt in.

Note:

To prevent soiling use:

- **CircoTherm hot air.** The CircoTherm hot air mode causes less soiling than the others.
- the universal pan **to bake** very moist cakes.
- suitable utensils (frying pan) **for frying.**

For easier cleaning

you can switch on the oven lamp and take off the oven door.

For cleaning the mating surface of the oven door at the front of the oven, the door should be removed.

Use hot soapy water or a vinegar solution.

It is best to use oven cleaner if the oven is very dirty. Only use oven cleaner in a cold oven.

We recommend cleaning gels because these can be applied with greater precision.

 Do not clean the warm oven with any of the cleaning products specifically designed for this purpose.

Leave the oven open so that it can dry after cleaning.

Note:

Enamel is baked on at very high temperatures. This can cause some slight colour variation. This is normal and does not affect the function. Do not use coarse scouring pads or strong cleaning agents to remove such discolorations.

The edges of thin trays cannot be completely enamelled. As a result, these edges can be rough. Anti-corrosion protection is guaranteed.

Enamel areas in the oven

Removing/installing the oven door

Oven door

Note: To make the manual cleaning steps following the automatic oven cleaning function more convenient, the appliance features the following options.

Removing the oven door

1. Fully open the oven door.
2. Move the catch levers on the right and left-hand sides to the fully open position.

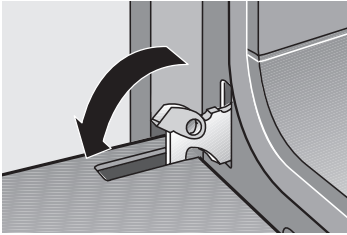

3. Placing the door at an upward angle toward you, grasp the door with both hands and lift it out of the hinges toward you.

When pulling the door out, make sure that you do not reach into the hinge. There is a risk of injury.

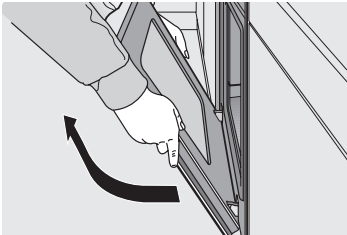

Hanging the oven door

1. Set both hinges into their respective receptacles on the left and right, and swing the oven door downward.
2. Close the catch levers on the left and right.
3. Close the oven door.

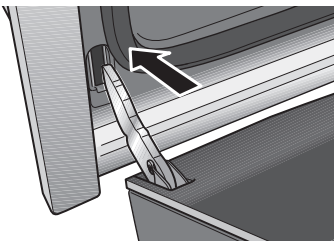

Shelf supports

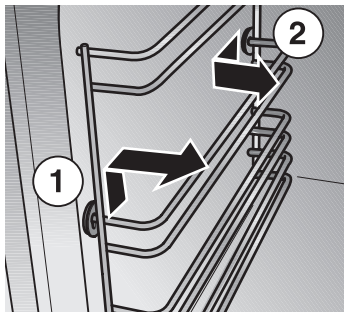

Removing

You can remove the shelf supports for cleaning.

- 1. At the front,** press the shelf support up and take it off.
- 2. At the back,** pull the shelf support forward and take it off.

Clean the shelf support using washing-up liquid and pan scrapers or brushes.

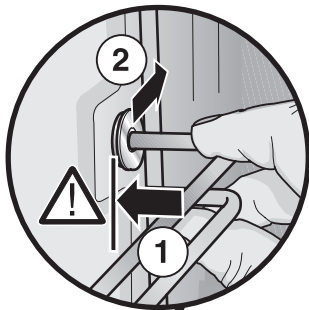

Replacing

The shelf supports fit on the left and right side.

The indentation (a) must always be at the bottom.

- 1. At the back,** put the shelf support in as far as it goes.
- 2.** Push the shelf support back.

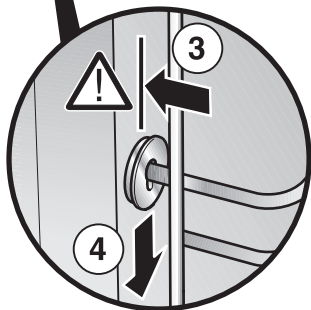
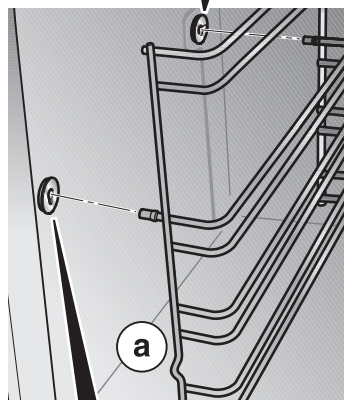

- 3.** Insert the front of the shelf support as far as it will go.
- 4.** Push the shelf support down.

Service and Repair Information

In the event of problems or repairs that you cannot solve or perform yourself, our customer service will be happy to help. Check the customer service directory for a customer service facility in your area.

Caution: Calling the customer service because of an operator error can be very costly!

E No and FD No

You can find this information on the appliance's nameplate. The nameplate is located on the appliance, behind the oven door, on the left bottom edge of the oven.

In the event of a customer service request, please have the following information handy:

E-Number	FD
----------	----

Replacing the oven light

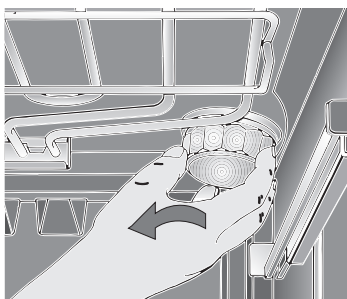

Caution: Unplug the appliance or remove the fuse! By actuating the miniature circuit-breaker or by unscrewing the fuses in the fuse box in your house.

1. To prevent damage, place a towel into the cold oven.
2. Unscrew the lamp cover by turning it counter-clockwise.
3. Replace the lamp.
 - Type: Incandescent bulb E 14, 220 – 240 V, 40 W, heat-resistant to 300° C
 - You may obtain this bulb from your customer service or from your appliance dealer.

Replacing the oven door seat

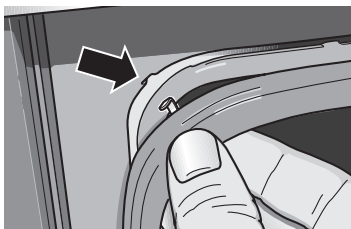

Remove the defective oven door seal by simply unhooking it.

You may obtain the new oven door seal from your customer service.

Trouble-shooting Guide

Calling the customer service is not always really necessary. In some cases, you can remedy the situation yourself. The following table may contain some helpful tips.

Important general safety guidelines:

Service or repair work on the electronic components may only be performed by a qualified expert. Without exception, prior to starting such repairs, the appliance must be disconnected from the mains. This may be accomplished by tripping the automatic fuse or by removing the fuse from the fuse box that controls your flat or apartment.

Problem	Possible cause	Remedy
. . . if there is a general failure of all electrical functions, i.e., the control lamps have suddenly ceased to function.	Defective fuse	Check the fuse in the fuse box, and replace if required.
. . . if liquids or thin viscous dough are distributed at a visibly uneven thickness?	The appliance has not been placed or installed plumb-and-level.	Level the appliance using the leveling feet, or check the installation.
. . . if the oven suddenly stop functioning?	The electronic clock is set to an automatic timing cycle.	Set electronic clock to operation without automatic timer: 1. Press the ◀▶ button. 2. Reset ON time ↪ to 0:00.
. . . if the oven suddenly stop functioning and the electronic clock flashes 0:00?	The power supply was briefly interrupted.	Reset the time of day.
. . . if electronically control functions fail?	Energy pulses (e.g. lightning flash).	Reset the relevant functions.

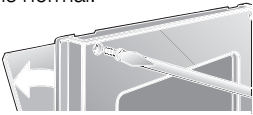
Problem	Possible cause	Remedy
. . . if smoke is generated during roasting or grilling?	Roasting temperature too high. Wire shelf or universal pan slid in incorrectly.	Place wire shelf into universal pan and insert together in shelf position.
. . . if enamelled slide-in parts show mat bright stains?	Normal occurrence due to dripping meat juices.	Not available.
. . . if the glass pane or window of the oven door become clouded?	Normal occurrence, due to existing temperature difference.	Switch on the oven for app. 5 minutes at 100° C.
. . . if the oven shows increasing condensation water?	Normal occurrence, e.g. in the case of cakes with very moist topping (fruit) or roasts.	Briefly open the oven door occasionally during baking or roasting, wipe up the condensation water after operation.
After prolonged use, the oven window panes are soiled from the inside.	This kind of soiling is normal. 	Remove the oven door , and put aside with the handle facing upward. For cleaning, remove the two screws at the door handle moulding with a screwdriver. Caution: During reassembly, install both the door handle and the door seal in their original positions.

Assembly Instructions

For the installer
and kitchen expert!

Important installation notes

Properly dispose of **packaging materials**.

Do not use **oven door handle** for transporting or handling the unit during installation.

WARNING: Connection and first start of the appliance may only be performed by an authorised specialist.

Connection have to be made using a mains connection cable not lighter than H05RR-F 300 V / 500 V Rubber Flexible Cable or H05VV-F 300V / 500V PVC Flexible Cable.

Rated consumption, rated voltage and type no. of the appliance:

See appliance nameplate behind the oven door to the left beneath the side edge of the oven.

The unit's nameplate is located at on the sidewall of the unit.

Electrical safety of the appliance can be ensured only if the equipment earth in the building installation has been installed according to regulations.

A separator must be installed in the household circuit. A suitable separator is a switch that has a contact gap of more than 3 mm and interrupts all poles. Other examples are LS switches, fuses and contactors.

The connection diagramm is located on the rear panel of the appliance.



In the case of repairs interrupt all power connections to the unit.

The properly installed appliance must be covered on all sides in such a fashion that not even components with rough insulation are exposed to the touch.

The cover must be removable with tools only.

Installation of the built-in oven

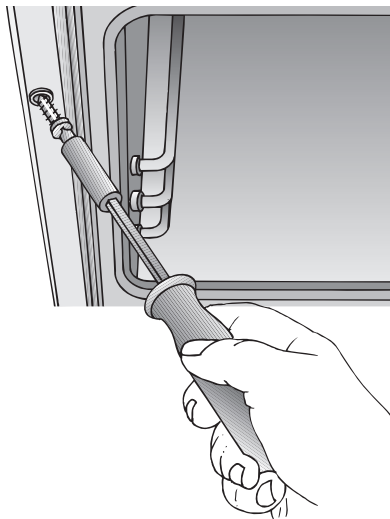

Push the oven into the cabinet aperture and align the unit until it is in a **level position**.

Open the oven door and, using one screw on each side, fasten the built-in oven to the side strips of the conversion cabinet.

When screwing in the two screws (enclosed in a bag with the built-in oven), ensure that they are pointing outwards at a slight angle. Please use these screws only.

Verify that the built-in oven is positioned securely and in a **level position**, and that the required installation dimensions have been maintained.

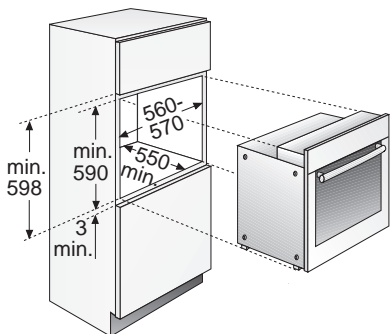

Furniture requirements

Oven housings from virtually all lines of kitchen furniture are suitable for installing the built-in oven. However, the veneers or plastic laminates on the conversion cabinets must be applied with heat-resistant adhesive (90 C).

If plastic laminates or cement are not sufficiently heat-resistant, warping, bubbling or detachment of the finish may result.

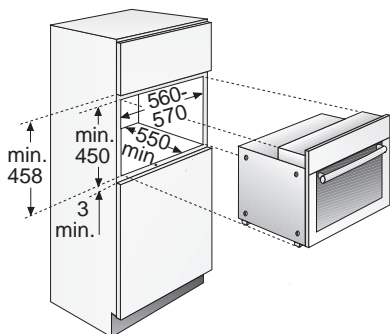

NEFF (UK) Ltd.
Grand Union House,
Old Wolverton Road,
Old Wolverton
Milton Keynes, MK12 5PT
Tel: 01908 328300
Fax: 01908 328399

9000 142 555
Printed in Germany 0806 Es.